



FRONTO MAX SLAT PANELS

FRONTO MAX SLAT PANELS

Fronto Max is a new solution for facade and soffit. The panels are manufactured using the innovative Max-3 technology thanks to which a profile was created that is extremely resistant to impacts and large temperature fluctuations. Fronto panels are waterproof, lightweight, maintenance-free, as well as quick and easy to install. This guarantees many years of trouble-free use.



DESIGNERS

„For some time now, we have been able to observe an interest in spatialising walls in interiors, and dressing them with 3D decorative elements. Especially popular nowadays are slat panels, which are mostly used for decorating single walls. These walls have also slowly started to „come out“ from houses covering balcony niches or terraces. Interiors and exteriors exchange furniture, accessories, and wall coverings. Hence came the idea for Fronto, to develop a new panel with a modern lamella shape. When designing the profile, I wanted to achieve the deepest possible shading between the lamellas. As a result, thanks to specially designed joints, the shadow impressively exposes individual lamellas. In this way, we achieved an effective three-dimensionality.”



DOROTA BALEWICZ



The V-Black collection is an attractive solution for finishing the exterior of a building. They give the facade a modern and elegant look while adding character and depth. The dark grouting contrasts with the patterns on the panels, creating a deepened 3D effect in the shape used. The introduced classic colour scheme of the panels with predominantly lighter oak patterns is a response to the modern and harmonious trend of being closer to the surrounding nature. In addition, panels with dark grouting can be easier to keep clean compared to light ones, which is important for facades exposed to external pollution.



NATALIA POLAKOWSKA



DISCOVER A WORLD OF POSSIBILITIES



Fronto Max is a versatile product that offers many design possibilities. The shape of the profile allows vertical and horizontal installation. Additionally, it can be combined with other VOX facade panels. Thanks to the range of patterns imitating the structure of wood, this creates unique designs both on the wall and on the ceiling. Depending on the project, Fronto will work well on the entire building or as a single touch on the facade.



VERTICAL VERSUS HORIZONTAL



Fronto Max panels can be installed in two ways - vertically or horizontally. The former gives the wall a modern and elegant look and great visual effect. The latter, through an elongated arrangement of lines, gives the wall a calm rhythm.

Panels can also be used as a decorative element, if we cover only a selected fragment of the elevation by placing them horizontally or vertically.

ON THE WALL AND ON THE CEILING



DESIGNER
DOROTA BALEWICZ

„A sense of atmospheric cosiness can be achieved by laying panels on the wall and ceiling at the same time. This arrangement makes the sharp angle invisible, and the two perpendicular planes blend seamlessly and aesthetically.”

COMPREHENSIVE OFFER



Thanks to the universal connection and assembly system, we can combine different panel collections such as the Max-3 system and the Infratop soffit on the facade and ceiling. This creates almost unlimited possibilities for creating compositions on different planes. The varying width of the elements combined in an individual rhythm will create the visual unity for the house.

IDEAL FOR SMALL CONTRUCTIONS



Fronto Max is a product that is also perfect for small constructions like extensions or mobile homes. The panels are lightweight and do not weigh down the structure. They are very durable and resistant to temperature fluctuations. Thanks to high quality printing, the colour stays on them for a long time and does not change colour. Additionally, the panels require no maintenance, and are easy to clean. Even after many years of use, they will look beautifully and modern.

MODERN SOLUTIONS

HURRICANE RESISTANT LOCK

This solution ensures better adhesion of the panels to the facade, and eliminates the noise the panels make in strong winds.

SYSTEM CLICK

A simple and quick way to connect panels on the facade and soffit.

MOUNTING HOLES

Pre-drilled mounting holes make installation quick and easy.

3D EFFECT

Light plays in the folds of the panels, creating interesting chiaroscuro, and the joints appear darker, which further enhances the 3D effect.

SELF-CLEANING STRUCTURE

The facade is easy to keep clean thanks to the special structure of the panel, on which dirt and dust does not settle.



ADVANTAGES

DESIGN

A perfect reflection of the colour and grain of the wood.



WATER-RESISTANCE

Panels and finishes are waterproof.



CONSERVATION

It does not require maintenance, which is time-consuming and expensive.



INSTALLATION

Can be mounted horizontally or vertically.



DESIGN CAPABILITIES

The panels can be used both on the wall as well as on the ceiling.



LIGHTNESS

Panels are lightweight and do not weigh down the structure.





MAX-3 TECHNOLOGY

INNOVATIVE TECHNOLOGY

The three-layer technology used in the production of Max-3 makes the panels combine high mechanical resistance with the possibilities of the polymer material in terms of shape, colour and structure.

TEMPERATURE RESISTANCE

The panels are characterized by reduced linear expansion, which ensures their high resistance to both low and very high temperatures.

DURABILITY OF METAL

The base layer of the panel is its core, which gives it a test-proven durability comparable to metal. Importantly, Max-3 panels do not corrode and do not load the structure.

BOTTOM

INTERMEDIATE

DECORATIVE LAYER



See the impact resistance test provided by the Max-3 technology.



VERSATILE COLOURS

Materials in wood colours are versatile, and offer many design possibilities. For this reason, they are often chosen for facade and ceiling finish. Thanks to the use of modern digital printing technology (Thermoprint), the panels have a matt finish, with an interesting and diverse pattern without the effect of repetition. Fronto Max is available in wooden decors and in wooden decors with dark grouts - V-Black collection. In the V-Black collection dark grouts emphasizes additionally 3D effect on the surface. All these features create a result which is closer to the perception of natural material. Wood-coloured facades and soffits blend well with other materials such as stone, plaster or brick.





OAK V-BLACK



LIHT OAK V-BLACK



GOLDEN OAK V-BLACK



WALNUT V-BLACK





OAK



HONEY OAK



WINCHESTER OAK



GOLDEN OAK



WALNUT



TROUBLE-FREE INSTALLATION

TYPICAL DESIGN AND TOOLS

The panels are mounted on a standard substructure (metal or wooden) without the need for special tools.

FINISHING TRIMS

Trims are versatile, and can be used in both Fronto Max and Max-3 panel installations, as well as Infratop soffit.

INSTALLATION POSSIBILITIES

The panels can be installed in a variety of ways: vertically or horizontally, on the wall or ceiling or combined with Max-3 facade panels or Infratop soffit.

FAST AND CLEAN

Slat panels mean clean installation with no dust during processing. The click system and pre-punched mounting holes streamline their connection, which greatly reduces installation time, outperforming plaster and wooden facades.



SYSTEM ELEMENTS

SXP 06
Slat panel

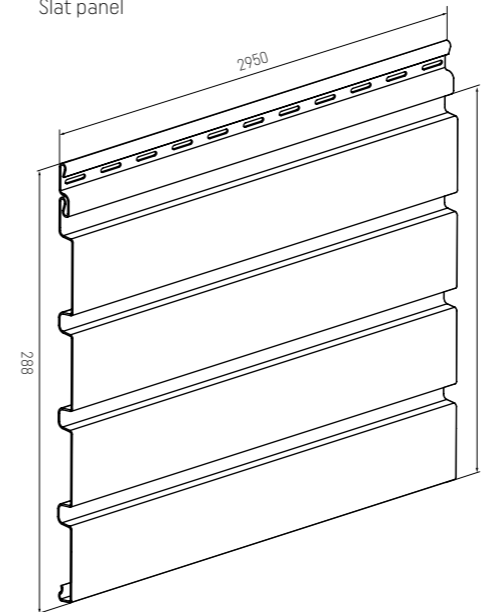

SV 11
Starter trim

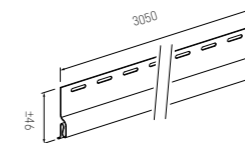

SV 11.5
Lower ventilation trim

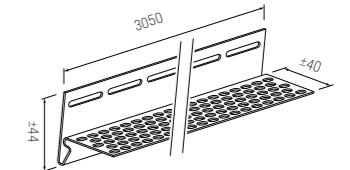

SVP 12
Outside corner

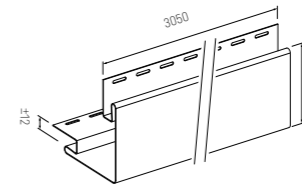

SVP 12 V
Outside corner for vertical installation

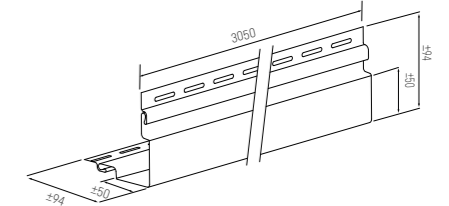

SVP 12,5
Outside corner mini

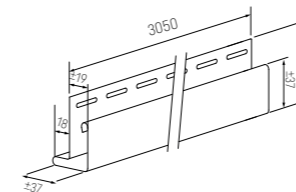

SVP 14
Finishing trim

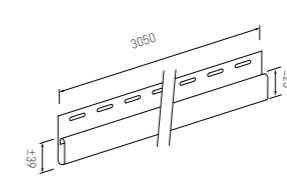

SVP 15
J trim

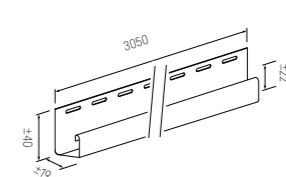

SVP 16.5
Drip edge

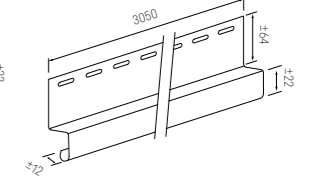

SVP 17
Facade flashing small

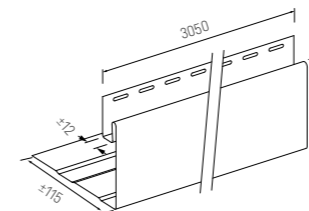

SVP 18
Joint trim

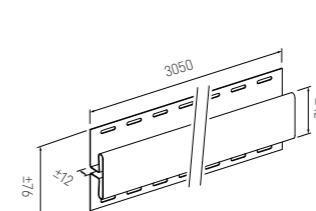

SVP 19
Facade flashing large

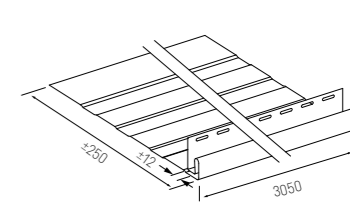

Scan QR code to see detailed installation instruction.



THINKING ABOUT NATURE



RECYCLING

Our products are made of thermoplastics, which are fully recyclable.



DURABILITY

Our products are extremely durable. The lifetime of many is 10 or even 30 years. Thanks to the resistance to a variety of external factors, their impact on the environment is significantly smaller than products with more frequent replacement causing additional wear raw materials, energy and waste generation.



MAINTENANCE

There is no need for maintenance over the entire lifetime, and therefore no additional chemicals (paints, preservatives, etc.) must be used, which means no harm to the environment.



INSULATION











Our claddings ensure proper ventilation of the facade and protect it against moisture. Additionally, they are an excellent cladding in the system of ventilated facades, which improves efficiency of heat of the building and reduces the need to burn fuels for heating purposes.



HEALTH

Our products are safe for health. They do not contain harmful substances (e.g. lead or cadmium) and do not release volatile organic compounds.

PRODUCT FEATURES

FEATURE	NORM	TEST RESULT	UNIT
 Low weight Facilitates transport and mounting		SV(P/PU)-06: 2,23 SX(P/PU)-06: 2,37	kg/m ²
 Water resistance			
 Impact resistance	PN-EN 13245-2:2009/AC:2010	Not less than 3J (-20,03oC), 3J (23,03oC)	J
 Incombustibility It does not burn, it melts	PN-EN 13245-2:2009/AC:2010	D-s3;d0	
 Resistance to UV rays Colour resistance	PN-EN 20105-A02:1996 PN-EN 13245-2:2009/AC:2010	not more than 3 SV/SX-06 A.8.60 SVP/PU SXP/SXPU-06 A.4.60	grayscale grade
 Lead and tin free			
 Resistance to changing weather conditions			
 Quick installation Wide covering width, built-in locks and factory made nail slots facilitate and speed up the installation			
 System Click Thanks to it, the assembly is easy and fast			
 Design possibilities The panels can be used both on the wall and on the ceiling.			
 Maintenance free No need for painting and other treatment			
 Easy to keep clean Can be clean with water and mild detergents			
 Recycled product 100% recyclable			
 30-year warranty on the product			



909034652*23900*



vox.pl/global